



# SMÅLAND COLLECTION

OAK TVETA





OAK VISTA

## SMÅLAND COLLECTION

The historic Småland region of Sweden - whose name means "small lands" - is known for beautiful dense forests covering the terrain. As a tribute to Kährs' homeland, the floors in this collection are named after the historic "small lands" in the Småland region. This collection features specially selected Oak planks with extreme character, individually treated based on its unique composition of knots, graining, and cracks. The result is a lively and rich floor with a natural lustre and feeling.







SMÅLAND COLLECTION

OAK VISTA

- Design:** Plank
- Features:** Rustic Oak, Stained, Brushed, Handscraped, Beveled Edges
- Surface Treatment:** Oil
- Wear Layer:** Approx. 3.5mm (1/8")
- Grading:** Dynamic
- Joint:** Woodloc® 5S
- Guarantee:** Lifetime Structural
- Installation:** Float, Glue-down, Nail-down

*This product may be floated over radiant heat.*

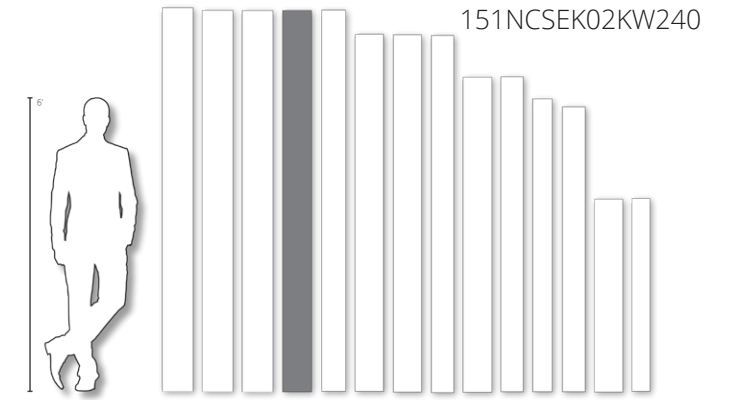

Length	Width	Thickness	Boards/Ctn	Area	Weight	Ctn/Pallet	Pallets/Cont.
95 1/4"	7 3/8"	5/8"	6	29.279ft²	49lbs	50	16

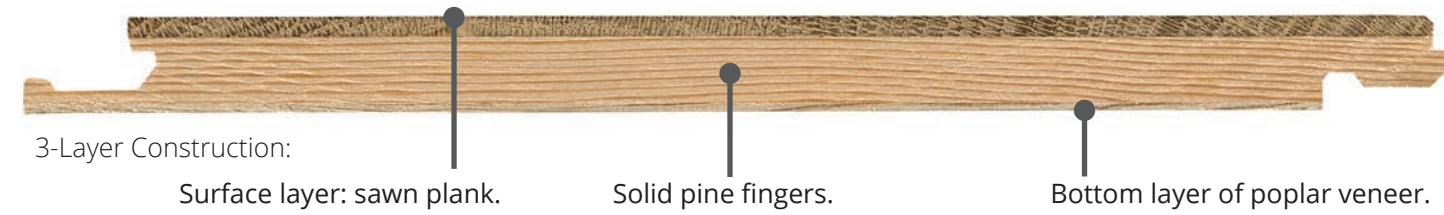

*This product must be oiled immediately after installation and prior to use.*







SMÅLAND COLLECTION

OAK ASPELAND

151NDSEK01KW240

- Design:** Plank
  - Features:** Rustic Oak, Stained, Brushed, Saw Marks, Handscraped, Beveled Edges
  - Surface Treatment:** Oil
  - Wear Layer:** Approx. 3.5mm (1/8")
  - Grading:** Expressive
  - Joint:** Woodloc® 5S
  - Guarantee:** Lifetime Structural
  - Installation:** Float, Glue-down, Nail-down
- This product may be floated over radiant heat.*

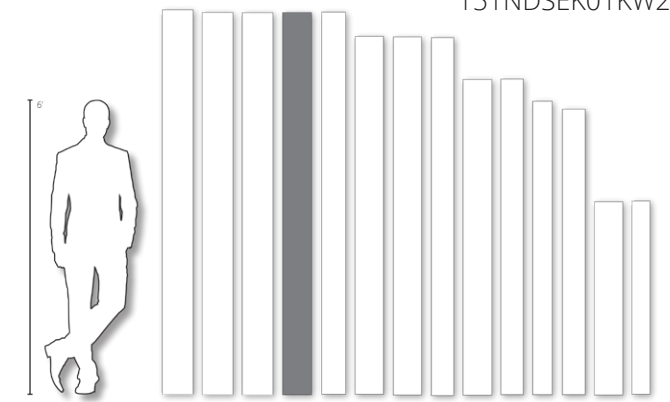

Length	Width	Thickness	Boards/Ctn	Area	Weight	Ctn/Pallet	Pallets/Cont.
95 1/4"	7 3/8"	5/8"	6	29.279ft <sup>2</sup>	49lbs	50	16



*This product must be oiled immediately after installation and prior to use.*







SMÅLAND COLLECTION

OAK MÖRE

151NCSEK03KW240

- Design:** Plank
- Features:** Rustic Oak, Stained, Brushed, Handscraped, Beveled Edges
- Surface Treatment:** Oil
- Wear Layer:** Approx. 3.5mm (1/8")
- Grading:** Dynamic
- Joint:** Woodloc® 5S
- Guarantee:** Lifetime Structural
- Installation:** Float, Glue-down, Nail-down

*This product may be floated over radiant heat.*

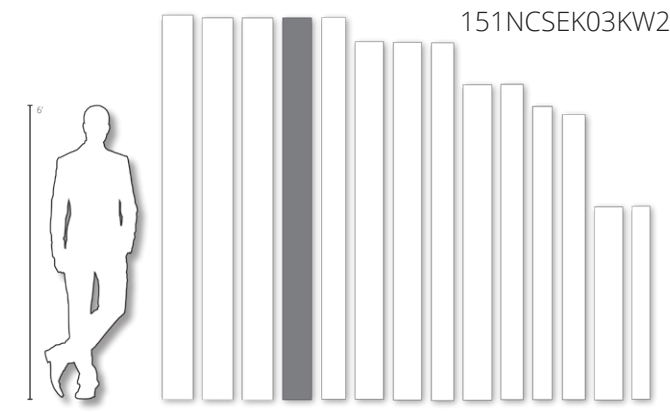

Length	Width	Thickness	Boards/Ctn	Area	Weight	Ctn/Pallet	Pallets/Cont.
95 1/4"	7 3/8"	5/8"	6	29.279ft <sup>2</sup>	49lbs	50	16



*This product must be oiled immediately after installation and prior to use.*







SMÅLAND COLLECTION

OAK VEDBO

151NCSEK01KW240

- Design:** Plank
  - Features:** Rustic Oak, Brushed, Handscraped, Beveled Edges
  - Surface Treatment:** Oil
  - Wear Layer:** Approx. 3.5mm (1/8")
  - Grading:** Dynamic
  - Joint:** Woodloc® 5S
  - Guarantee:** Lifetime Structural
  - Installation:** Float, Glue-down, Nail-down
- This product may be floated over radiant heat.*

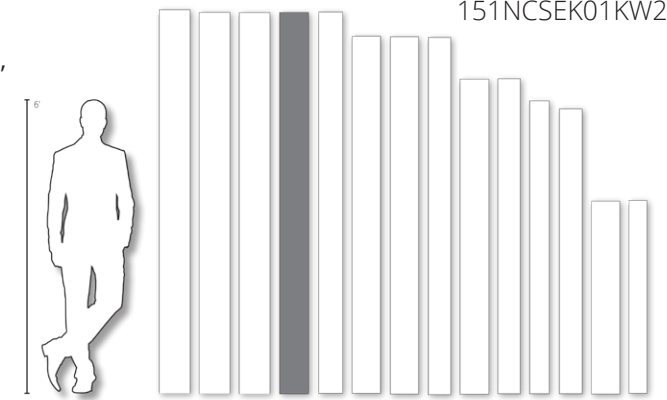

Length	Width	Thickness	Boards/Ctn	Area	Weight	Ctn/Pallet	Pallets/Cont.
95 1/4"	7 3/8"	5/8"	6	29.279ft <sup>2</sup>	49lbs	50	16



*This product must be oiled immediately after installation and prior to use.*







SMÅLAND COLLECTION

OAK FINNVEDEN

151NDSEK03KW240

- Design:** Plank
  - Features:** Rustic Oak, Stained, Brushed, Saw Marks, Handscraped, Beveled Edges
  - Surface Treatment:** Oil
  - Wear Layer:** Approx. 3.5mm (1/8")
  - Grading:** Expressive
  - Joint:** Woodloc® 5S
  - Guarantee:** Lifetime Structural
  - Installation:** Float, Glue-down, Nail-down
- This product may be floated over radiant heat.*

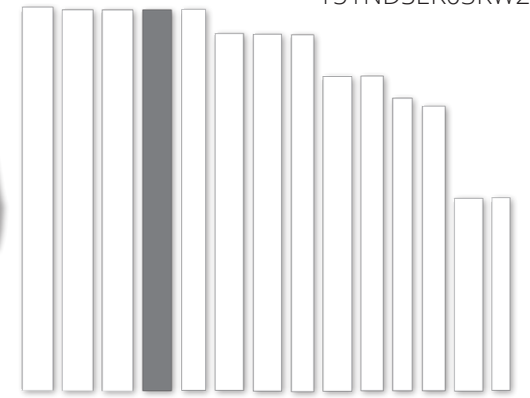

Length	Width	Thickness	Boards/Ctn	Area	Weight	Ctn/Pallet	Pallets/Cont.
95 1/4"	7 3/8"	5/8"	6	29.279ft <sup>2</sup>	49lbs	50	16



3-Layer Construction:

Surface layer: sawn plank.

Solid pine fingers.

Bottom layer of poplar veneer.

*This product must be oiled immediately after installation and prior to use.*







SMÅLAND COLLECTION

OAK YDRE

151NCSEK04KW240

- Design:** Plank
  - Features:** Rustic Oak, Stained, Brushed, Handscraped, Lightly Smoked, Beveled Edges
  - Surface Treatment:** Oil
  - Wear Layer:** Approx. 3.5mm (1/8")
  - Grading:** Dynamic
  - Joint:** Woodloc® 5S
  - Guarantee:** Lifetime Structural
  - Installation:** Float, Glue-down, Nail-down
- This product may be floated over radiant heat.*

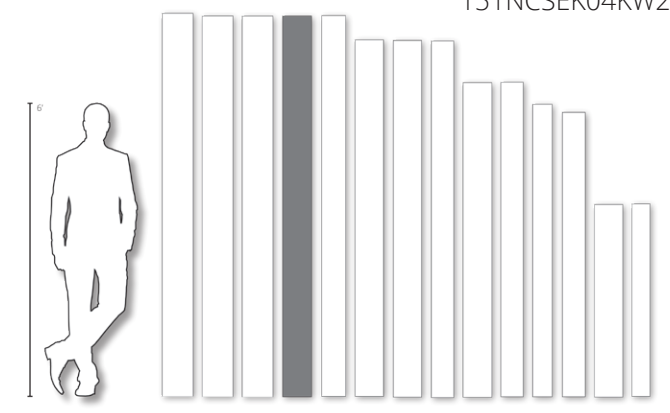

Length	Width	Thickness	Boards/Ctn	Area	Weight	Ctn/Pallet	Pallets/Cont.
95 1/4"	7 3/8"	5/8"	6	29.279ft <sup>2</sup>	49lbs	50	16



*This product must be oiled immediately after installation and prior to use.*







SMÅLAND COLLECTION

OAK TVETA

151NDSEK04KW240

- Design:** Plank
- Features:** Rustic Oak, Stained, Brushed, Handscraped, Lightly Smoked, Saw Marks, Beveled Edges
- Surface Treatment:** Oil
- Wear Layer:** Approx. 3.5mm (1/8")
- Grading:** Expressive
- Joint:** Woodloc® 5S
- Guarantee:** Lifetime Structural
- Installation:** Float, Glue-down, Nail-down

*This product may be floated over radiant heat.*



Length	Width	Thickness	Boards/Ctn	Area	Weight	Ctn/Pallet	Pallets/Cont.
95 1/4"	7 3/8"	5/8"	6	29.279ft <sup>2</sup>	49lbs	50	16



3-Layer Construction:

Surface layer: sawn plank.

Solid pine fingers.

Bottom layer of poplar veneer.

*This product must be oiled immediately after installation and prior to use.*







SMÅLAND COLLECTION

OAK SEVEDE

151NCSEK05KW240

- Design:** Plank
- Features:** Rustic Oak, Stained, Brushed, Handscraped, Lightly Smoked, Beveled Edges
- Surface Treatment:** Oil
- Wear Layer:** Approx. 3.5mm (1/8")
- Grading:** Dynamic
- Joint:** Woodloc® 5S
- Guarantee:** Lifetime Structural
- Installation:** Float, Glue-down, Nail-down

*This product may be floated over radiant heat.*

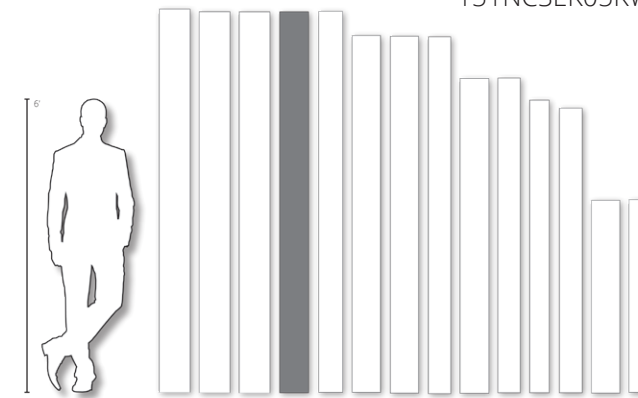

Length	Width	Thickness	Boards/Ctn	Area	Weight	Ctn/Pallet	Pallets/Cont.
95 1/4"	7 3/8"	5/8"	6	29.279ft <sup>2</sup>	49lbs	50	16



3-Layer Construction:

Surface layer: sawn plank.

Solid pine fingers.

Bottom layer of poplar veneer.

*This product must be oiled immediately after installation and prior to use.*







SMÅLAND COLLECTION

OAK HANDBÖRD

151NDSEK06KW240

- Design:** Plank
  - Features:** Rustic Oak, Handscraped, Stained, Brushed, Lightly Smoked, Saw Marks, Beveled Edges
  - Surface Treatment:** Oil
  - Wear Layer:** Approx. 3.5mm (1/8")
  - Grading:** Expressive
  - Joint:** Woodloc® 5S
  - Guarantee:** Lifetime Structural
  - Installation:** Float, Glue-down, Nail-down
- This product may be floated over radiant heat.*

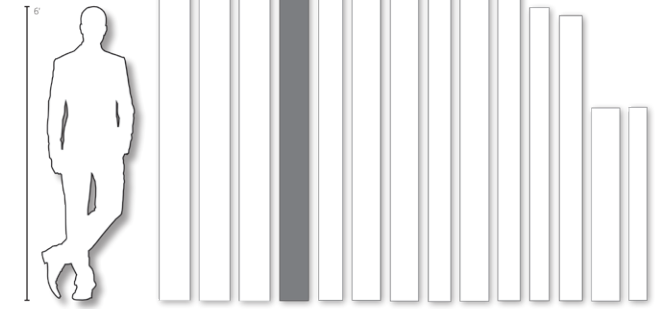

Length	Width	Thickness	Boards/Ctn	Area	Weight	Ctn/Pallet	Pallets/Cont.
95 1/4"	7 3/8"	5/8"	6	29.279ft <sup>2</sup>	49lbs	50	16



3-Layer Construction:

Surface layer: sawn plank.

Solid pine fingers.

Bottom layer of poplar veneer.

*This product must be oiled immediately after installation and prior to use.*





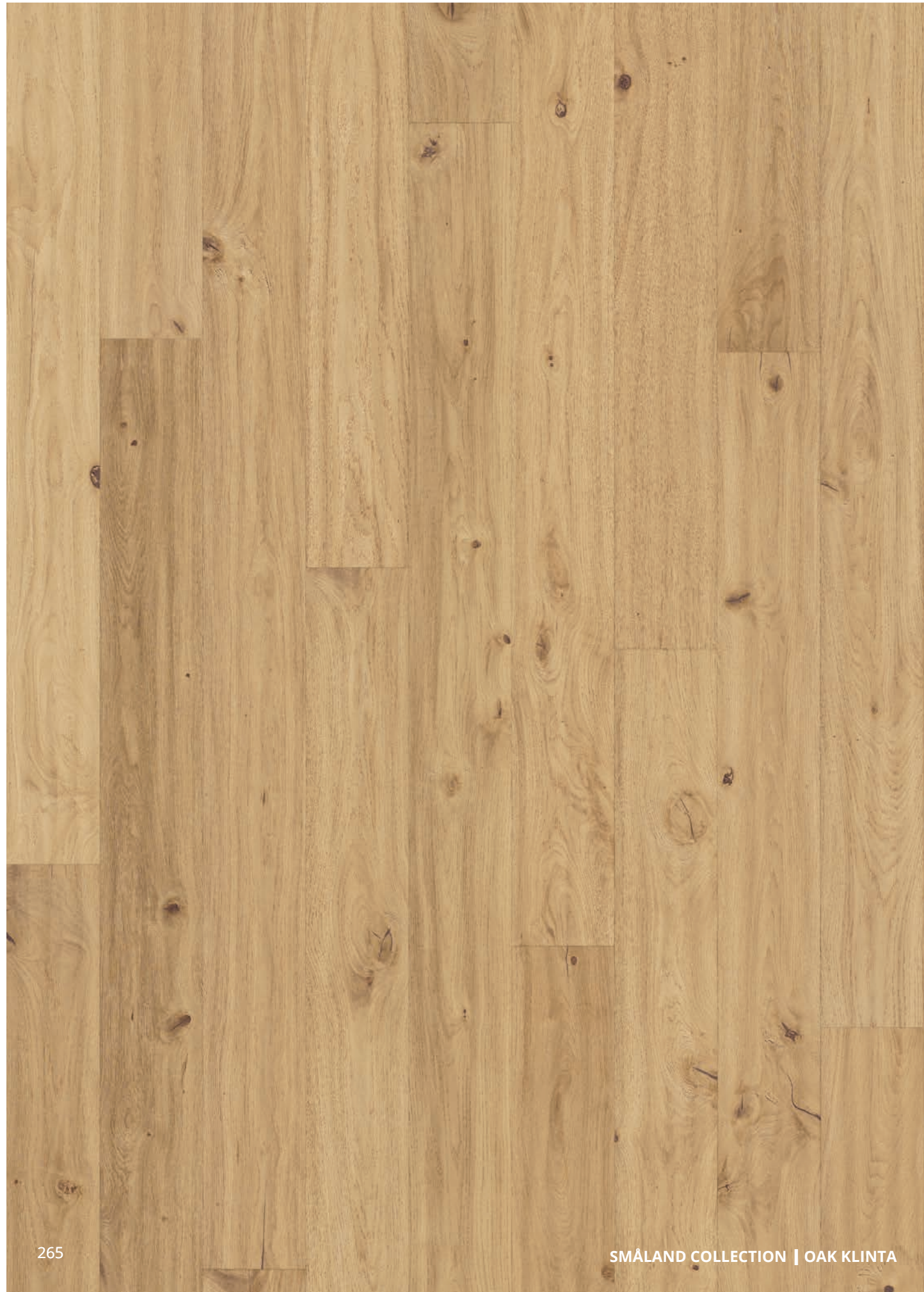

SMÅLAND COLLECTION

- Design:** Plank
- Features:** Rustic Oak, Stained, Brushed, Handscraped, Beveled Edges
- Surface Treatment:** Oil
- Wear Layer:** Approx. 3.5mm (1/8")
- Grading:** Dynamic
- Joint:** Woodloc® 5S
- Guarantee:** Lifetime Structural
- Installation:** Float, Glue-down, Nail-down

*This product may be floated over radiant heat.*

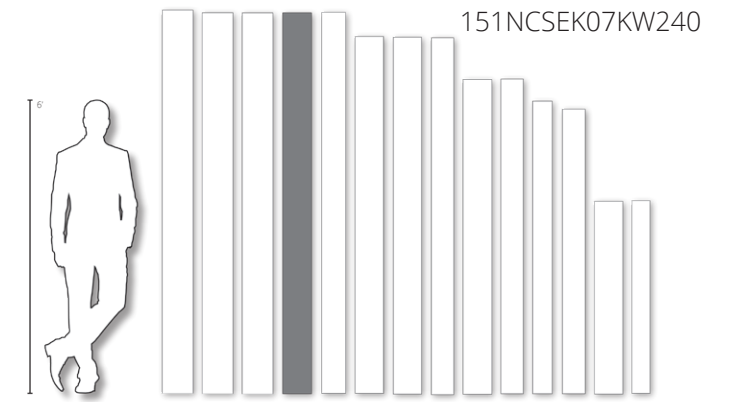

Length	Width	Thickness	Boards/Ctn	Area	Weight	Ctn/Pallet	Pallets/Cont.
95 1/4"	7 3/8"	5/8"	6	29.279ft <sup>2</sup>	49lbs	50	16



*This product must be oiled immediately after installation and prior to use.*







## KÄHR'S COMPLETE FLOORING SYSTEM FOR HARDWOOD FLOORS

Kährs offers a wide range of tools and materials to make installation easy and help achieve a perfect end result. The range includes a variety of underlayments, installation tools, and moldings, as well as maintenance products specially designed for our hardwood floors.

Please email [info@kahrs.com](mailto:info@kahrs.com) for more information on ordering maintenance products and accessories.



**MOLDINGS FOR ALL KÄHRS WOOD FLOORS**

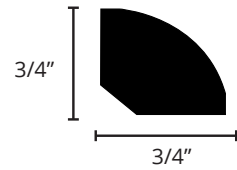

**QUARTER ROUND**

Conceals expansion space between the wall and Kährs hardwood flooring. Also used to transition between wood flooring and cabinetry.

Applicable Collections	Molding Dimensions	Pieces per Order	Shipment Weight
All Floors	3/4" x 3/4" x 78"	10	10 lbs

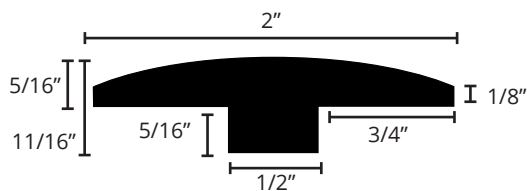

**T-MOLDING**

Used in doorways to blend flooring surfaces in adjoining rooms or where floors of the same thickness meet.

Applicable Collections	Molding Dimensions	Pieces per Order	Shipment Weight
All Floors	2" x 11/16" x 78"	5	25 lbs

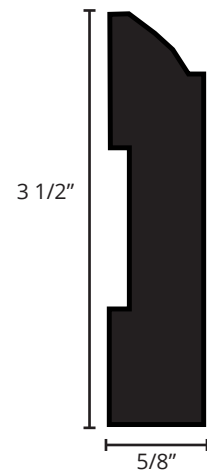

**WALL BASE**

Provides an elegant, traditional transition from the flooring to wall. Gives any room a more formal, finished appearance.

Applicable Collections	Molding Dimensions	Pieces per Order	Shipment Weight
All Floors	5/8" x 3 1/2" x 78"	5	25 lbs

**SQUARE NOSE REDUCER**

Installed against vertical surfaces such as patio doors or fireplace hearths.

Applicable Collections	Molding Dimensions	Pieces per Order	Shipment Weight
Kährs Life (7mm)	1 1/2" x 3/4" x 78"	5	10 lbs
Kährs Avanti (13mm)   Kährs Original, Supreme, ID (15mm)	1 1/2" x 7/8" x 78"	5	10 lbs

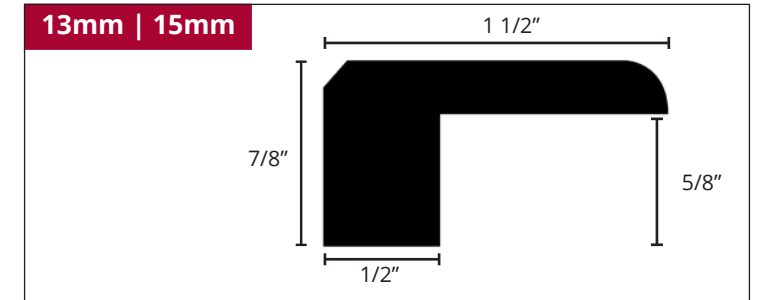
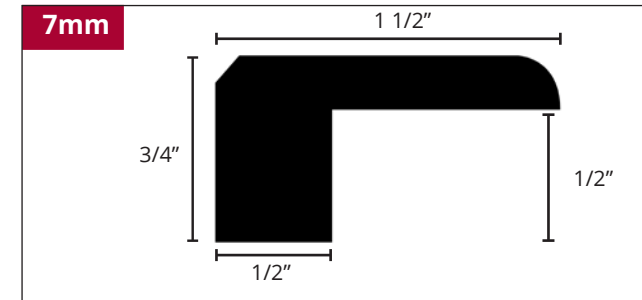

**OVERLAP REDUCER**

Used with floating floor applications to provide a smooth transition between floors of different heights. Overlap profile allows the installed flooring to expand and contract.

Applicable Collections	Molding Dimensions	Pieces per Order	Shipment Weight
Kährs Life (7mm)	1 1/2" x 3/8" x 78"	5	10 lbs
Kährs Avanti (13mm)   Kährs Original, Supreme, ID (15mm)	2 3/8" x 3/4" x 78"	5	10 lbs

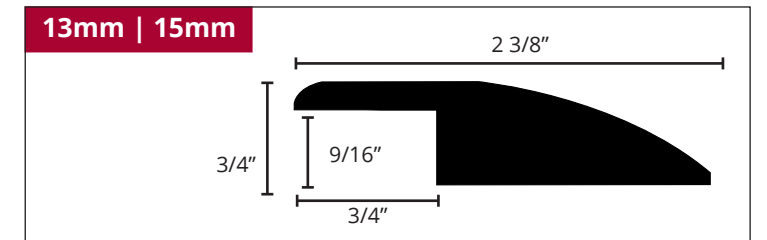
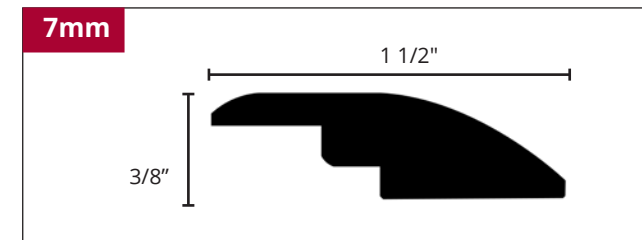

**THRESHOLD**

Ideal for doorways or to transition between floors of different heights. Used with wood, tile or carpet.

Applicable Collections	Molding Dimensions	Pieces per Order	Shipment Weight
Kährs Life (7mm)	2" x 3/4" x 78"	10	10 lbs
Kährs Avanti (13mm)   Kährs Original, Supreme, ID (15mm)	2" x 7/8" x 78"	5	10 lbs

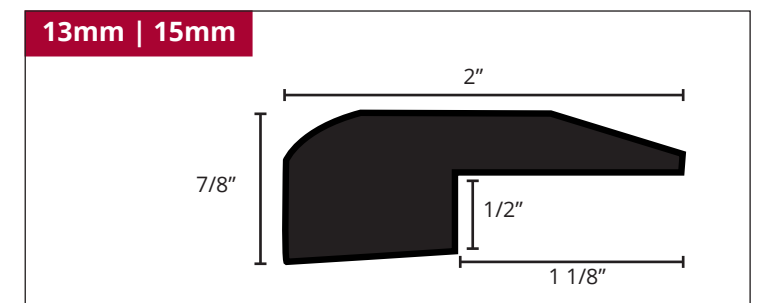
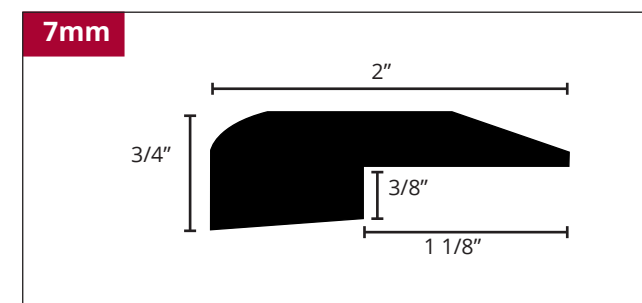



## OVERLAP STAIR NOSINGS

Applicable Collections	Molding Dimensions	Pieces per Order	Shipment Weight
Kährs Life (7mm)	2" x 13/16" x 78"	5	20 lbs
Kährs Avanti (13mm)   Kährs Original, Supreme, ID (15mm)	3" x 13/16" x 78"	5	20 lbs

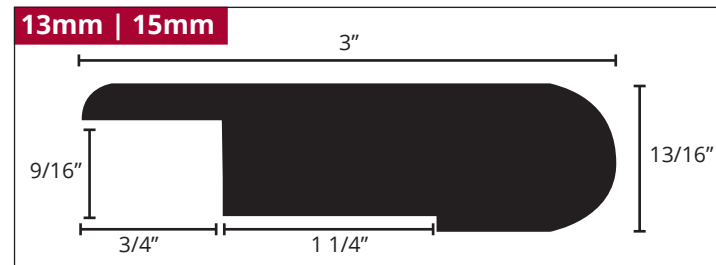
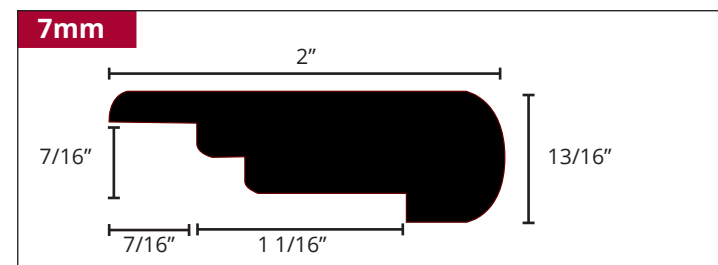

## WOODLOC® FLUSH STAIR NOSINGS

Applicable Collections	Molding Dimensions	Pieces per Order	Shipment Weight
Kährs Avanti (13mm)	2 7/8" x 13/16" x 78"	5	20 lbs
Kährs Original, Supreme (15mm)	3 3/8" x 13/16" x 78"	5	20 lbs

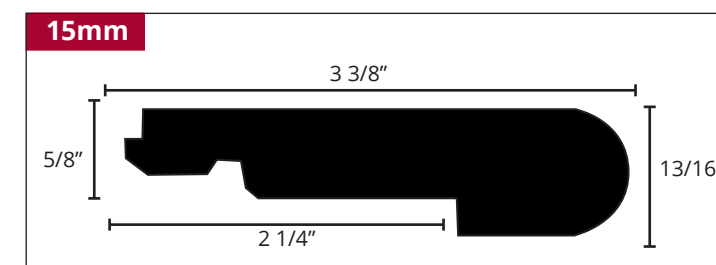
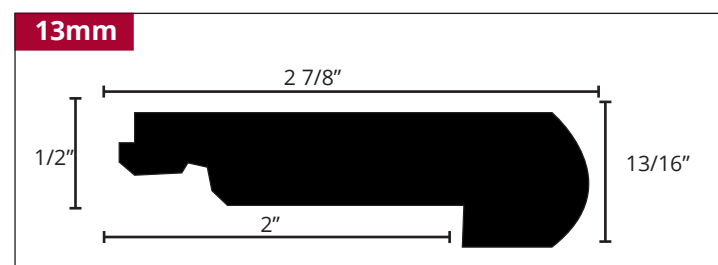

## FLUSH STAIR NOSINGS, WOODLOC®

Applicable Collections	Molding Dimensions	Pieces per Order	Shipment Weight
Kährs Life (7mm)	2" x 13/16" x 78"	5	20 lbs

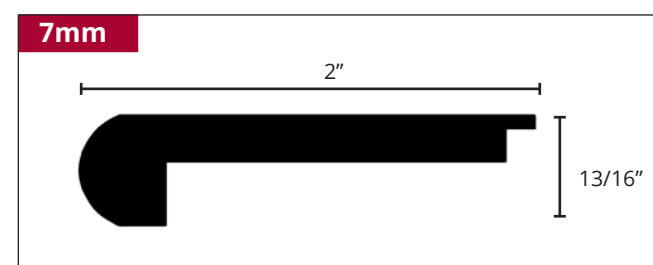

## FLUSH STAIR NOSINGS, TONGUE & GROOVE

Applicable Collections	Molding Dimensions	Pieces per Order	Shipment Weight
Kährs ID (15mm)	3" x 13/16" x 78"	5	20 lbs

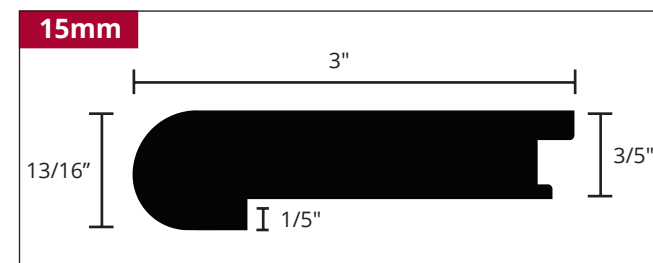

## Transition Profile

T-Molding 7mm, 10mm  
 T-Molding 13mm, 15mm  
 Square Nose 7mm, 10mm  
 Square Nose 13mm, 15mm  
 Threshold 7mm, 10mm  
 Threshold 13mm, 15mm  
 Overlap Reducer 7mm  
 Overlap Reducer 10mm  
 Overlap Reducer 13mm, 15mm

## Setback Distance

1 1/2"  
 1 1/2"  
 7/8"  
 1 1/4"  
 3/8"  
 1 3/8"  
 1 3/8"  
 2 1/8"  
 2 1/4"



### Kährs Floor Cleaner

710804

32 oz. bottle Kährs Floor Cleaner  
 Can be used on both Kährs Hardwood and Kährs Luxury Tile Products.



### Kährs Satin Oil

710553

No mixing required!

TO BE USED IMMEDIATELY AFTER INSTALLATION AND PRIOR TO USE OF THE FLOOR

Apply a thin layer of Kährs Satin Oil on the surface and spread it evenly with a Kährs Micro Fiber Mop or a dry cloth along the grain of the board. Polish again with a new Micro Fiber Mop head after 10-15 minutes so that no residue is left behind. 1 l of Kährs Satin Oil per 2,000ft².

1 liter  
 2 lbs



## HARDWOOD FLOORING MAINTENANCE PRODUCTS

### Kährs Floor Care Kit

710526

Maintenance kit containing: dry mop, bottle of Kährs Cleaner, and Kährs Floor Care Guide.  
1 kit per carton  
5 lbs



### Microfiber Replacement Pad

710512

Replacement pad for dry mop.  
2 lbs



[CLICK TO RETURN TO TABLE OF CONTENTS](#)

## HARDWOOD FLOORING UNDERLAYMENTS

### Kährs Combo System

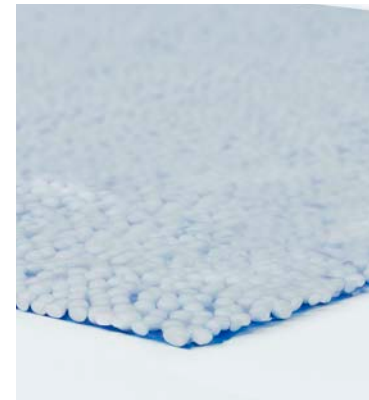

Roll Coverage	100 ft <sup>2</sup>	630 ft <sup>2</sup>
Roll Length	30'	189'
Roll Width	40"	40"
Thickness	1/8"	1/8"
Roll Weight	3 lbs, 3 oz	21 lbs
Roll Diameter	7 1/8"	16 1/2"
Item Number	710100	710107
Sound Rating	IIC = 68	

- Helps level the subfloor
- Provides moisture barrier/ventilation
- Compressibility-holds its shape under heavy loads
- Meets requirements for Kährs Lifetime Guarantee
- Mold reducing, inert and non-reactive construction
- Lightweight with Integrated overlap seal
- Ideal for radiant heating

### Kährs Eco+



Roll Coverage	100 ft <sup>2</sup>	450 ft <sup>2</sup> *
Roll Length	33' 4"	75'
Roll Width	3'	6'
Thickness	1/8"	1/8"
Roll Weight	16 lbs	74 lbs
Roll Diameter	7"	11"
Item Number	711100	711450*
Sound Rating	IIC = 70	

- Excellent acoustical performance
- Meets requirements for Kährs Lifetime Guarantee
- Lightweight with Integrated overlap seal
- 100% high density memory foam
- Premium polyurethane construction
- Guaranteed over radiant heat
- UL GreenGuard GOLD certified
- Breathable moisture barrier;  
Up to 10lbs moisture emission
- Ultra-fresh antimicrobial protection
- Free from formaldehyde, latex, PBDE's
- Made in part with natural resources
- 100% recyclable
- Eligible for LEED credits

\*Special Order

### Kährs QuietStride 2.0



Roll Coverage	300 ft <sup>2</sup>
Roll Length	75'
Roll Width	48"
Thickness	1/8"
Roll Weight	120 lbs
Roll Diameter	9"
Item Number	710112
Sound Rating	IIC = 57

- Glue down, floating installations
- Enhances underfoot comfort
- Conceals minor subfloor irregularities
- Always lays flat and will not slip during installation
- Approved for 'double-stick' installations
- 92% recycled tire content and 100% recyclable
- FloorScore certified & Contributes to LEED credits
- Guaranteed over radiant heat
- Resists mold, mildew, and fungus growth